

EMA34 Series

# Performance Gas Spring Aluminium Monitor Arms

## When Style Meets Function

Designed with a compact V shape, the sleek arms of the EMA34 Series release space and free you from desktop chaos. It improves work productivity by supporting side-by-side monitors, allowing for easy and personalized adjustments.

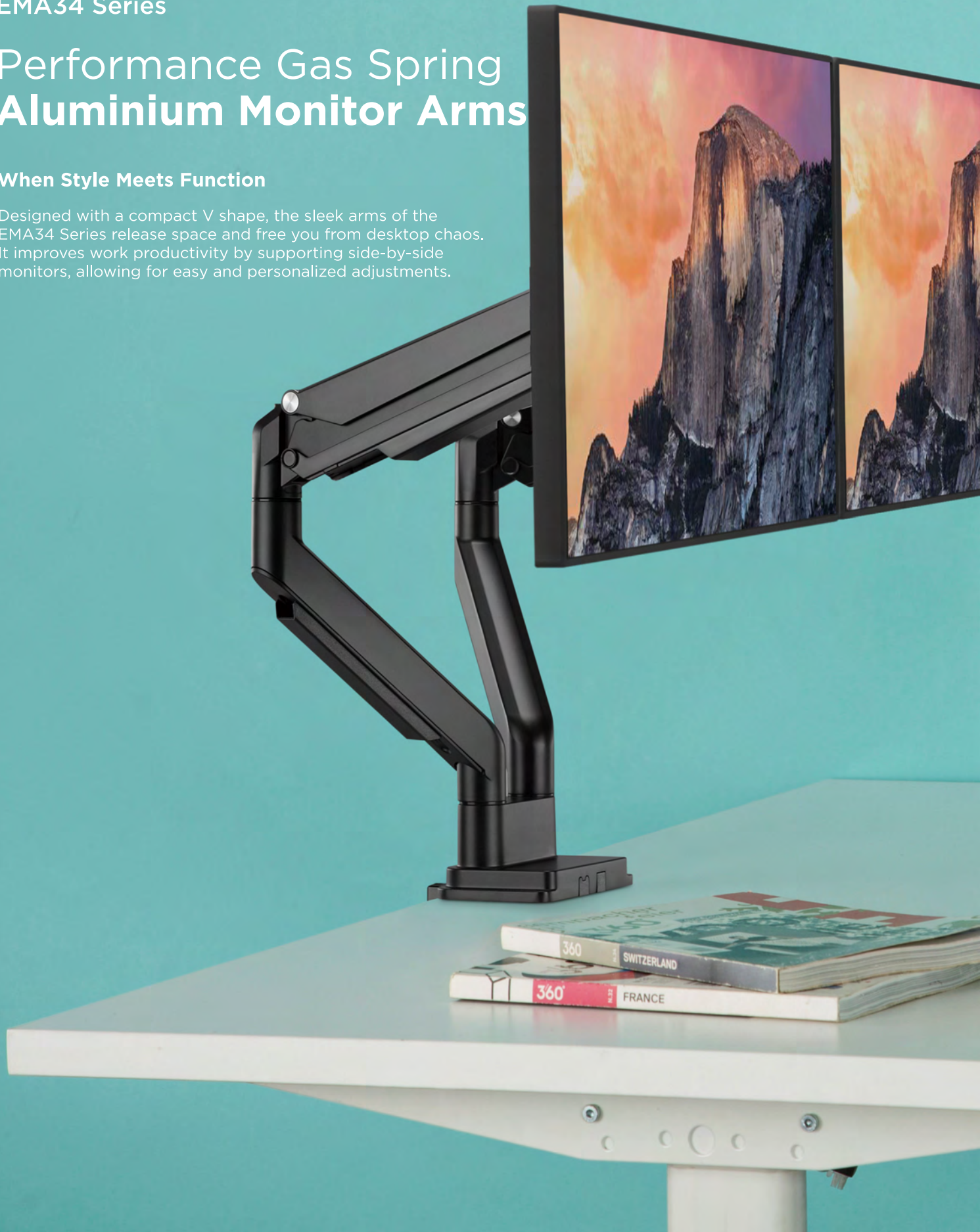

# EMA34 Series

## Performance Gas Spring Aluminium Monitor Arms



www.Ergovida.com.au

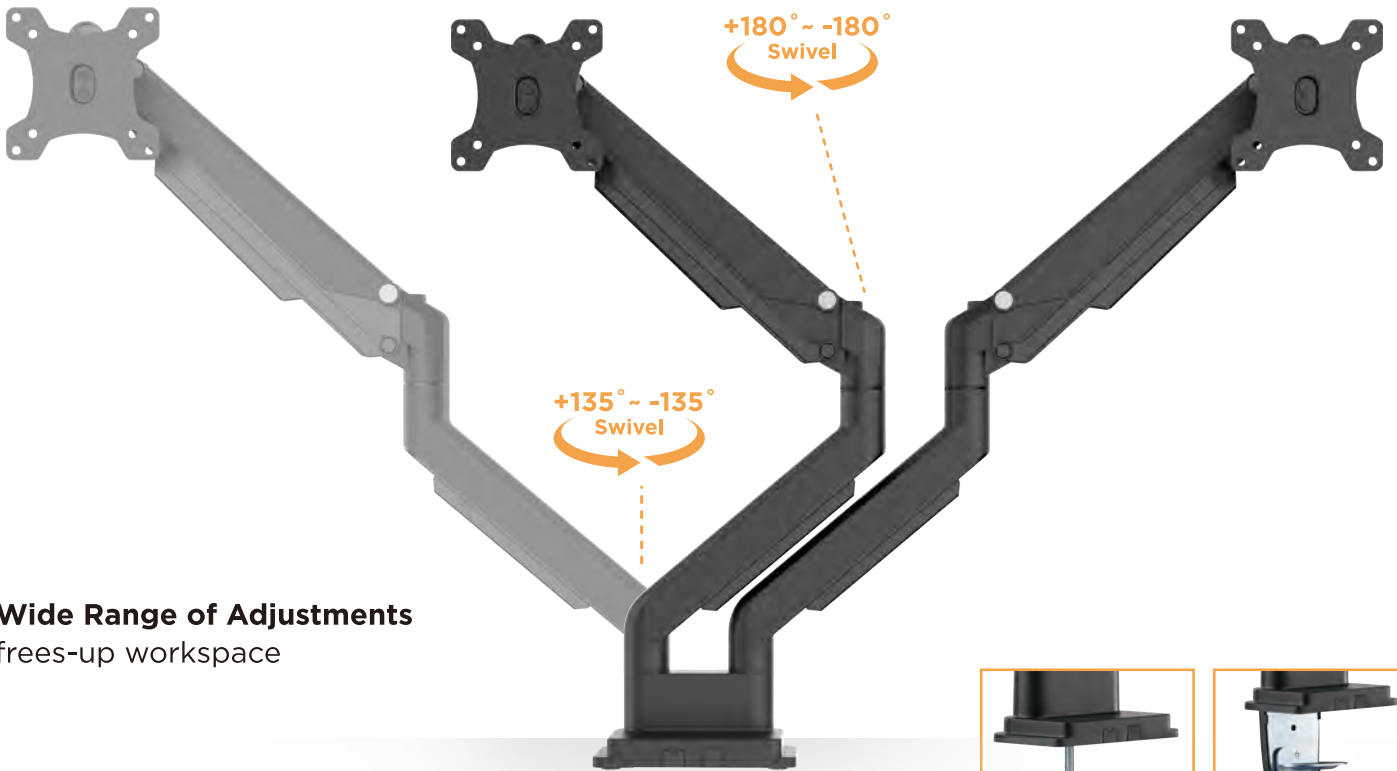

**Wide Range of Adjustments**  
frees-up workspace



**Clamp & Grommet Mounts Included**  
mounts to most any style desktop

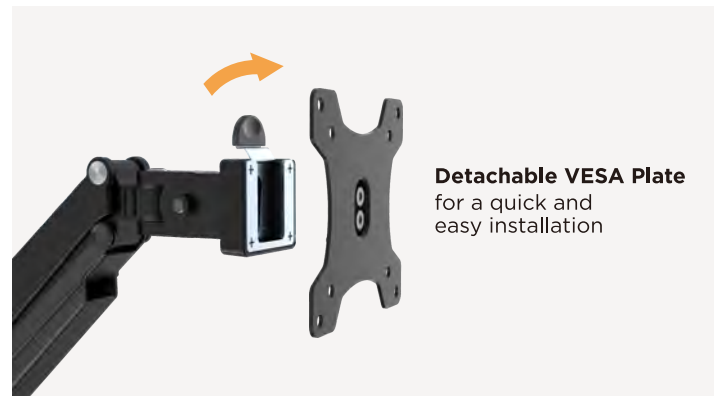

# EMA34 Series

## Performance Gas Spring Aluminium Monitor Arms

**Ergovida**

www.Ergovida.com.au

### EMA34-C12

For Single Monitor



Screen Size  
17"-32"

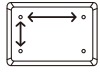

VESA Compatible  
75x75 100x100



Weight Capacity  
1-9kg/2.2-19.8lbs



Tilt Range  
+90° - -90°

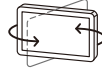

Swivel Range  
+90° - -90°



Screen Rotation  
+90° - -90°



Detachable  
VESA Plate

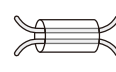

Cable  
Management

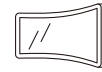

Curved Monitor

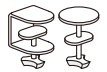

Clamp & Grommet  
Installation

Colours: ■

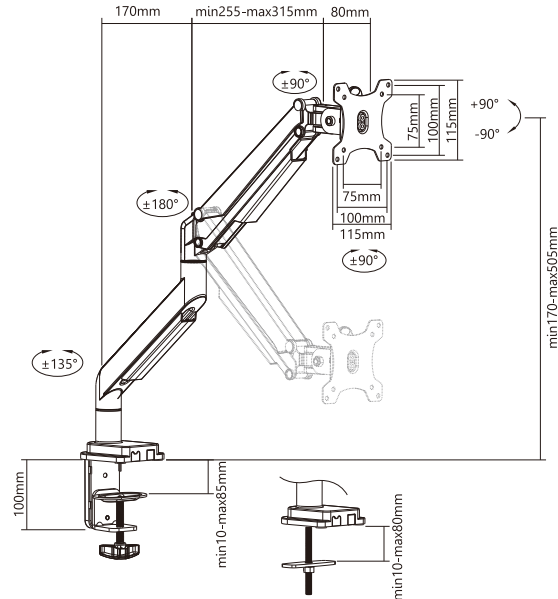

### EMA34-C24

For Dual Monitors



Screen Size  
17"-32"

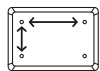

VESA Compatible  
75x75 100x100



Weight Capacity  
1-9kg/2.2-19.8lbs  
(x2)



Tilt Range  
+90° - -90°

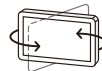

Swivel Range  
+90° - -90°



Screen Rotation  
+90° - -90°



Detachable  
VESA Plate

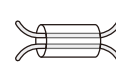

Cable  
Management



Curved Monitor



Clamp & Grommet  
Installation

Colours: ■

